

# CO-119C/P1201 Series

19" TFT-LCD Open Frame Panel PC with Intel® Elkhart Lake Atom® x6000E Series Processor



## ALL-NEW OPEN FRAME PANEL PC

| CO-100/P1000 Series Fits Any Machine Perfectly |

### Overview

[CONTACT](#)

The CO-100/P1201 is an open-frame panel PC with an Intel® Atom® (Elkhart Lake) processor, rich native I/O interfaces (GbE LAN, USB 3.2, COM, and DIO), expansion slots (Mini PCIe and M.2 Key E Type 2230), and CFM (to add PoE and IGN). The major highlight, especially for equipment manufacturers, is the exclusive adjustable mounting bracket (patent pending) that provides thickness adjustment and two panel-locking methods that make installation more convenient and reduce the need for customization during integration. The design fits cabinets of different materials and thicknesses for consistency and its robust design takes into account the requirements of HMI in harsh industrial environments.

### Key Features

- 19" TFT-LCD with Projected Capacitive Touch
- Intel® Elkhart Lake Atom® x6425E/x6211E Processor
- 1x DDR4 SO-DIMM
- Designed with Adjustable Mounting Bracket
- Support Flat / Standard / VESA / Rack Mount
- Front Panel IP65 Compliant
- Wide Operating Temperature
- Cincoze Patent CDS Technology Support

### Certifications



### Next-gen Performance

The CO-100/P1201 supports up to an Intel® Atom® x6425E (Elkhart Lake) 4-core processor, with 1.7 times the single-thread performance, 1.5 times the multi-thread performance, and double the graphics performance of the previous-generation Apollo Lake processor. Up to 32 GB of 3200 MHz DDR4 is supported.

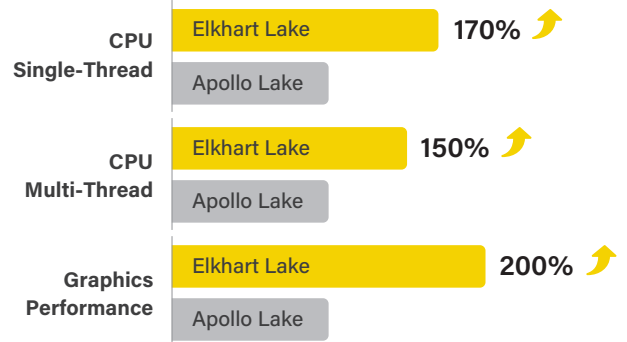

### Patented CDS Technology

Convertible Display System (CDS), the patented technology that connects the CO-100 display module to the P1201 embedded computer, has the advantages of easy maintenance in the field and easy future upgrades because the screen size can be changed and performance can be improved by only replacing a single part, rather than the whole system, saving on upgrade costs.

Patent No. M482908

### Easy to Install

The exclusive adjustable mounting bracket has flexible thickness adjustment and supports panel- and boss-type locking methods for industrial machines with flat mount or standard mount, making integration easier and more convenient.

Patent No.: D224544, D224545, I802427

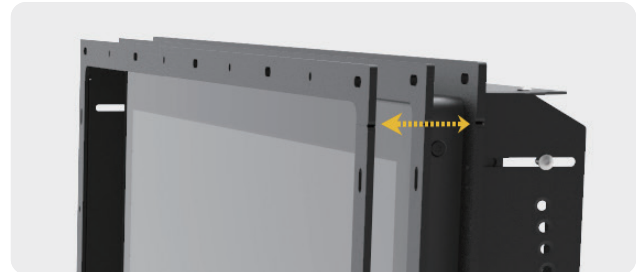

### Integrated Structure

The flexible and reliable design of the open-frame architecture enables deployment in equipment machines, and after removing the mounting bracket can be installed directly using the VESA mount for standalone use, or installed in a 19" rack for display function.

### Robust, Safe, Reliable

The CO-100/P1201 series has industrial-grade protections, including fanless design, wide operating temperature, wide-range DC power input (9 to 48 VDC), and IP65 front panel dust and water resistance, to face harsh and dangerous use environments such as field-side HMI applications.



## CO-119C Specifications

| Model Name              | CO-119C   |
|-------------------------|---|
| <b>Display</b>          |   |
| LCD Size                | • 19" (5:4)   |
| Resolution              | • 1280 x 1024   |
| Brightness              | • 350 cd/m2   |
| Contrast Ratio          | • 1000 : 1  |
| LCD Color               | • 16.7M   |
| Pixel Pitch             | • 0.294 (H) x 0.294 (V)   |
| Viewing Angle           | • 170 (H) / 160 (V)   |
| Backlight LED Life Time | • 50,000 hrs (LED Backlight)  |
| <b>Touch Screen</b>     |   |
| Touchscreen Type        | • Projected Capacitive Touch  |
| <b>Physical</b>         |   |
| Dimension (W x D x H)   | • 472.8 x 397.5 x 63mm  |
| Weight                  | • 6.91kg  |
| Construction            | • One-piece and Slim Bezel Design   |
| Mounting Type           | • Flat / Standard / VESA / Rack Mount   |
| Mounting Bracket        | • Pre-installed Mounting Bracket with Adjustable Design ( Support 11 different stages of adjustment )   |
| <b>Power</b>            |   |
| Power Consumption       | • 21W (Max.)  |
| <b>Protection</b>       |   |
| Ingress Protection      | • Front Panel IP65 Compliant * According to IEC60529  |
| <b>Environment</b>      |   |
| Operating Temperature   | • 0°C - 50°C (with Industrial Grade peripherals; Ambient with air flow)   |
| Storage Temperature     | • -20°C to 60°C   |
| Humidity                | • 80% RH @ 50°C (Non-condensing)  |
| EMC                     | • CE, UKCA, FCC, ICES-003 Class A   |
| EMI                     | <ul style="list-style-type: none"> <li>• CISPR 32 Conducted &amp; Radiated: Class A</li> <li>• EN/BS EN 55032 Conducted &amp; Radiated: Class A</li> <li>• EN/BS EN IEC 61000-3-2 Harmonic current emissions: Class A</li> <li>• EN/BS EN61000-3-3 Voltage fluctuations &amp; flicker</li> <li>• FCC 47 CFR Part 15B, ICES-003 Conducted &amp; Radiated: Class A</li> </ul>   |
| EMS                     | <ul style="list-style-type: none"> <li>• EN/IEC 61000-4-2 ESD: Contact: 4 kV; Air: 8 kV</li> <li>• EN/IEC 61000-4-3 RS: 80 MHz to 1000 MHz: 3 V/m</li> <li>• EN/IEC 61000-4-4 EFT: AC Power: 1 kV; DC Power: 0.5 kV; Signal: 0.5 kV</li> <li>• EN/IEC 61000-4-5 Surges: AC Power: 2 kV; Signal: 1 kV</li> <li>• EN/IEC 61000-4-6 CS: 3V</li> <li>• EN/IEC 61000-4-8 PFMF: 50 Hz, 1A/m</li> <li>• EN/IEC 61000-4-11 Voltage Dips &amp; Voltage Interruptions: 0.5 cycles at 50 Hz</li> </ul> |

## P1201 Specifications

| Model Name                                 | P1201   |
|--|---|
| <b>System</b>                              |   |
| Processor                                  | <ul style="list-style-type: none"> <li>• Intel® Atom® x6425E Processor (1.5M Cache, up to 3.00 GHz, 12W)</li> <li>• Intel® Atom® x6211E Processor (1.5M Cache, up to 3.00 GHz, 6W)</li> </ul> |
| Memory                                     | <ul style="list-style-type: none"> <li>• 1x DDR4 SO-DIMM Socket</li> <li>• Supports DDR4 3200MHz Memory Up to 32GB (un-buffered and non-ECC)</li> </ul>                                       |
| BIOS                                       | <ul style="list-style-type: none"> <li>• AMI BIOS</li> </ul>  |
| <b>Graphics</b>                            |   |
| Graphics Engine                            | <ul style="list-style-type: none"> <li>• Integrated Intel® UHD Graphics</li> </ul>  |
| Maximum Display Output                     | <ul style="list-style-type: none"> <li>• Supports Triple Independent Display</li> </ul>   |
| CDS  | <ul style="list-style-type: none"> <li>• 1x CDS Connector (1920 x 1080 @60Hz)</li> </ul>  |
| DP   | <ul style="list-style-type: none"> <li>• 1x DisplayPort Connector (4096 x 2304 @ 60Hz, According to CPU Specifications)</li> <li>* Verified maximum resolution: 3840 x 2160 @60Hz</li> </ul>  |
| VGA  | <ul style="list-style-type: none"> <li>• 1x VGA Connector (1920 x 1200 @60Hz)</li> </ul>  |
| <b>Audio</b>                               |   |
| Audio Codec                                | <ul style="list-style-type: none"> <li>• Realtek® ALC888, High Definition Audio</li> </ul>  |
| Line-out                                   | <ul style="list-style-type: none"> <li>• 1x Line-out, Phone Jack 3.5mm</li> </ul>   |
| Mic-in                                     | <ul style="list-style-type: none"> <li>• 1x Mic-in, Phone Jack 3.5mm</li> </ul>   |
| <b>I/O</b>                                 |   |
| LAN  | <ul style="list-style-type: none"> <li>• 2x 1GbE LAN, RJ45</li> <li>- GbE1: Intel® I210</li> <li>- GbE2: Intel® I210</li> </ul>   |
| COM  | <ul style="list-style-type: none"> <li>• 3x RS-232/422/485 with Auto Flow Control (Supports 5V/12V), DB9</li> </ul>   |
| USB  | <ul style="list-style-type: none"> <li>• 3x 10Gbps USB 3.2 Gen2, Type A</li> <li>• 1x 480Mbps USB 2.0, Type A</li> </ul>  |
| DIO  | <ul style="list-style-type: none"> <li>• 8x Isolated DIO (4x DI/4x DO), 10-Pin Terminal Block</li> </ul>  |
| <b>Storage</b>                             |   |
| SSD/HDD                                    | <ul style="list-style-type: none"> <li>• 1x 2.5" Front Accessible SATA HDD/SSD Drive Bay ( SATA3.0 )</li> </ul>   |
| mSATA                                      | <ul style="list-style-type: none"> <li>• 1x mSATA Socket (SATA 3.0, shared by Mini-PCIe socket)</li> </ul>  |
| <b>Expansion</b>                           |   |
| Mini PCI Express                           | <ul style="list-style-type: none"> <li>• 1x Full-size Mini-PCIe Socket</li> </ul>   |
| SIM Socket                                 | <ul style="list-style-type: none"> <li>• 1x SIM Socket</li> </ul>   |
| M.2  | <ul style="list-style-type: none"> <li>• 1x M.2 Key E Type 2230 Socket, Support Wireless Module</li> </ul>  |
| CFM (Control Function Module) Interface    | <ul style="list-style-type: none"> <li>• 1x CFM IGN Interface for optional CFM-IGN Module Expansion</li> <li>• 1x CFM PoE Interface for optional CFM-PoE Module Expansion</li> </ul>          |
| CDS (Convertible Display System) Interface | <ul style="list-style-type: none"> <li>• 1x CDS Interface for Convertible Display Module</li> </ul>   |
| <b>Other Function</b>                      |   |
| Clear CMOS Switch                          | <ul style="list-style-type: none"> <li>• 1x Clear CMOS Switch</li> </ul>  |
| Reset Button                               | <ul style="list-style-type: none"> <li>• 1x Reset Button</li> </ul>   |

|                                     |   |
|-------------------------------------|---|
| Instant Reboot                      | <ul style="list-style-type: none"> <li>• Support 0.2sec Instant Reboot Technology</li> </ul>  |
| Watchdog Timer                      | <ul style="list-style-type: none"> <li>• Software Programmable Supports 256 Levels System Reset</li> </ul>  |
| OSD Button                          | <ul style="list-style-type: none"> <li>• LCD On/Off, Brightness Up, Brightness Down</li> </ul>  |
| Internal Speaker                    | <ul style="list-style-type: none"> <li>• AMP 2W + 2W</li> </ul>   |
| Status LED Indicator                | <ul style="list-style-type: none"> <li>• Power LED, HDD LED, Temperature LED</li> </ul>   |
| <b>Power</b>                        |   |
| Power Button                        | <ul style="list-style-type: none"> <li>• 1x ATX Power On/Off Button</li> </ul>  |
| Power Mode Switch                   | <ul style="list-style-type: none"> <li>• 1x AT/ATX Mode Switch</li> </ul>   |
| Power Input                         | <ul style="list-style-type: none"> <li>• 9 - 48VDC, 3-pin Terminal Block</li> </ul>   |
| Remote Power On/Off                 | <ul style="list-style-type: none"> <li>• 1x Remote Power On/Off, 2-pin Terminal Block</li> </ul>  |
| Remote Power LED                    | <ul style="list-style-type: none"> <li>• 1x Remote Power LED, 2-pin Terminal Block</li> </ul>   |
| <b>Operating System</b>             |   |
| Windows                             | <ul style="list-style-type: none"> <li>• Windows® 10</li> </ul>   |
| Linux                               | <ul style="list-style-type: none"> <li>• Supports by project</li> </ul>   |
| <b>Physical</b>                     |   |
| Dimension ( W x D x H )             | <ul style="list-style-type: none"> <li>• 204.5 x 149 x 41.5 mm</li> </ul>   |
| Weight Information                  | <ul style="list-style-type: none"> <li>• 1.54 kg</li> </ul>   |
| Mechanical Construction             | <ul style="list-style-type: none"> <li>• Extruded Aluminum with Heavy Duty Metal</li> </ul>   |
| Mounting                            | <ul style="list-style-type: none"> <li>• Wall / VESA / CDS / DIN Rail</li> </ul>  |
| Physical Design                     | <ul style="list-style-type: none"> <li>• Fanless Design</li> <li>• Jumper-less Design</li> </ul>  |
| <b>Reliability &amp; Protection</b> |   |
| Reverse Power Input Protection      | <ul style="list-style-type: none"> <li>• Yes</li> </ul>   |
| Over Voltage Protection             | <ul style="list-style-type: none"> <li>• Protection Range: 51~58V</li> <li>• Protection Type: shut down operating voltage, re-power on at the preset level to recover</li> </ul>  |
| Over Current Protection             | <ul style="list-style-type: none"> <li>• 15A</li> </ul>   |
| CMOS Battery Backup                 | <ul style="list-style-type: none"> <li>• SuperCap Integrated for CMOS Battery Maintenance-free Operation</li> </ul>   |
| MTBF                                | <ul style="list-style-type: none"> <li>• 283,091 Hours - Database: Telcordia SR-332 Issue3, Method 1, Case 3</li> </ul>   |
| <b>Environment</b>                  |   |
| Operating Temperature               | <ul style="list-style-type: none"> <li>• -40°C to 70°C</li> <li>* PassMark BurnInTest: 100% CPU, 2D/3D Graphics (without thermal throttling)</li> <li>* With extended temperature peripherals; Ambient with air flow</li> <li>* According to IEC60068-2-1, IEC60068-2-2, IEC60068-2-14</li> </ul> |
| Storage Temperature                 | <ul style="list-style-type: none"> <li>• -40°C to 85°C</li> </ul>   |
| Relative Humidity                   | <ul style="list-style-type: none"> <li>• 95%RH @ 70°C (non-Condensing)</li> </ul>   |
| Shock                               | <ul style="list-style-type: none"> <li>• Operating, 50 Grms (w/ SSD, according to IEC60068-2-27)</li> </ul>   |
| Vibration                           | <ul style="list-style-type: none"> <li>• Operating, 5 Grms, 5-500 Hz, 3 Axes (w/ SSD, according to IEC60068-2-64)</li> <li>• Operating, 1 Grms, 10-500 Hz, 3 Axes (w/ SSD, according to IEC60068-2-6)</li> </ul>  |
| EMC                                 | <ul style="list-style-type: none"> <li>• CE, UKCA, FCC, ICES-003 Class A</li> <li>• EN IEC 61000-6-4, EN IEC 61000-6-2(24VDC Input Only)</li> </ul>   |

|        |  |
|--------|--|
| EMI    | <ul style="list-style-type: none"> <li>• CISPR 32 Conducted &amp; Radiated: Class A</li> <li>• EN/BS EN 55032 Conducted &amp; Radiated: Class A</li> <li>• EN/BS EN IEC 61000-3-2 Harmonic current emissions: Class A</li> <li>• EN/BS EN61000-3-3 Voltage fluctuations &amp; flicker</li> <li>• FCC 47 CFR Part 15B, ICES-003 Conducted &amp; Radiated: Class A</li> </ul>  |
| EMS    | <ul style="list-style-type: none"> <li>• EN/IEC 61000-4-2 ESD: Contact: 4 kV; Air: 8 kV</li> <li>• EN/IEC 61000-4-3 RS: 80 MHz to 1000 MHz: 10 V/m</li> <li>• EN/IEC 61000-4-4 EFT: AC Power: 2 kV; DC Power: 1 kV; Signal: 1 kV</li> <li>• EN/IEC 61000-4-5 Surges: AC Power: 2 kV; Signal: 1 kV</li> <li>• EN/IEC 61000-4-6 CS: 10V</li> <li>• EN/IEC 61000-4-8 PFMF: 50 Hz, 30A/m</li> <li>• EN/IEC 61000-4-11 Voltage Dips &amp; Voltage Interruptions: 1 cycles at 60 Hz</li> </ul> |
| Safety | <ul style="list-style-type: none"> <li>• UL, cUL, CB, IEC/EN 62368-1</li> </ul>  |

**CO-119C/P1201 External Layout**

**Front I/O**

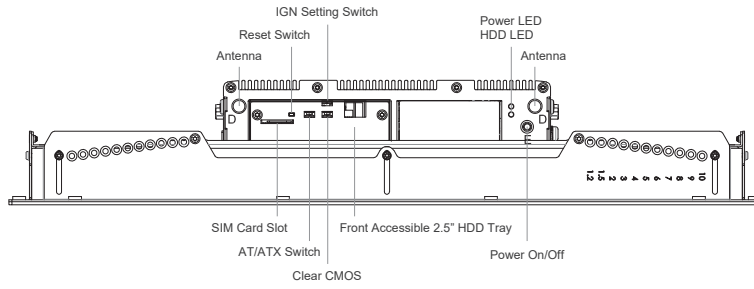

**Rear I/O**

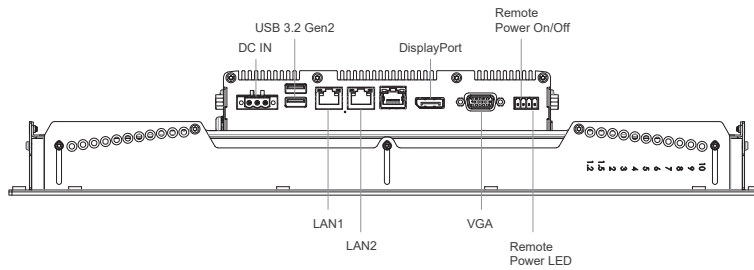

**Left I/O**

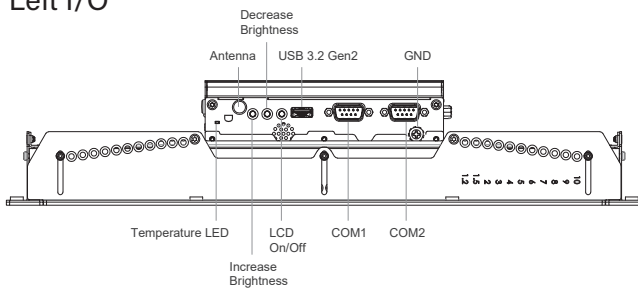

**Right I/O**

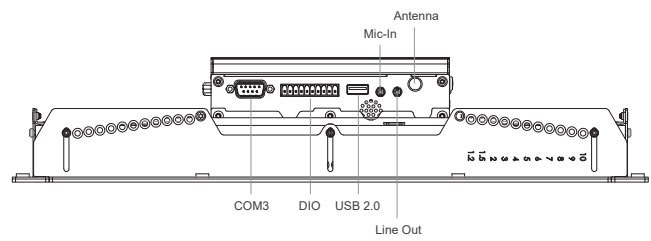

**CO-119C/P1201 Dimensions**

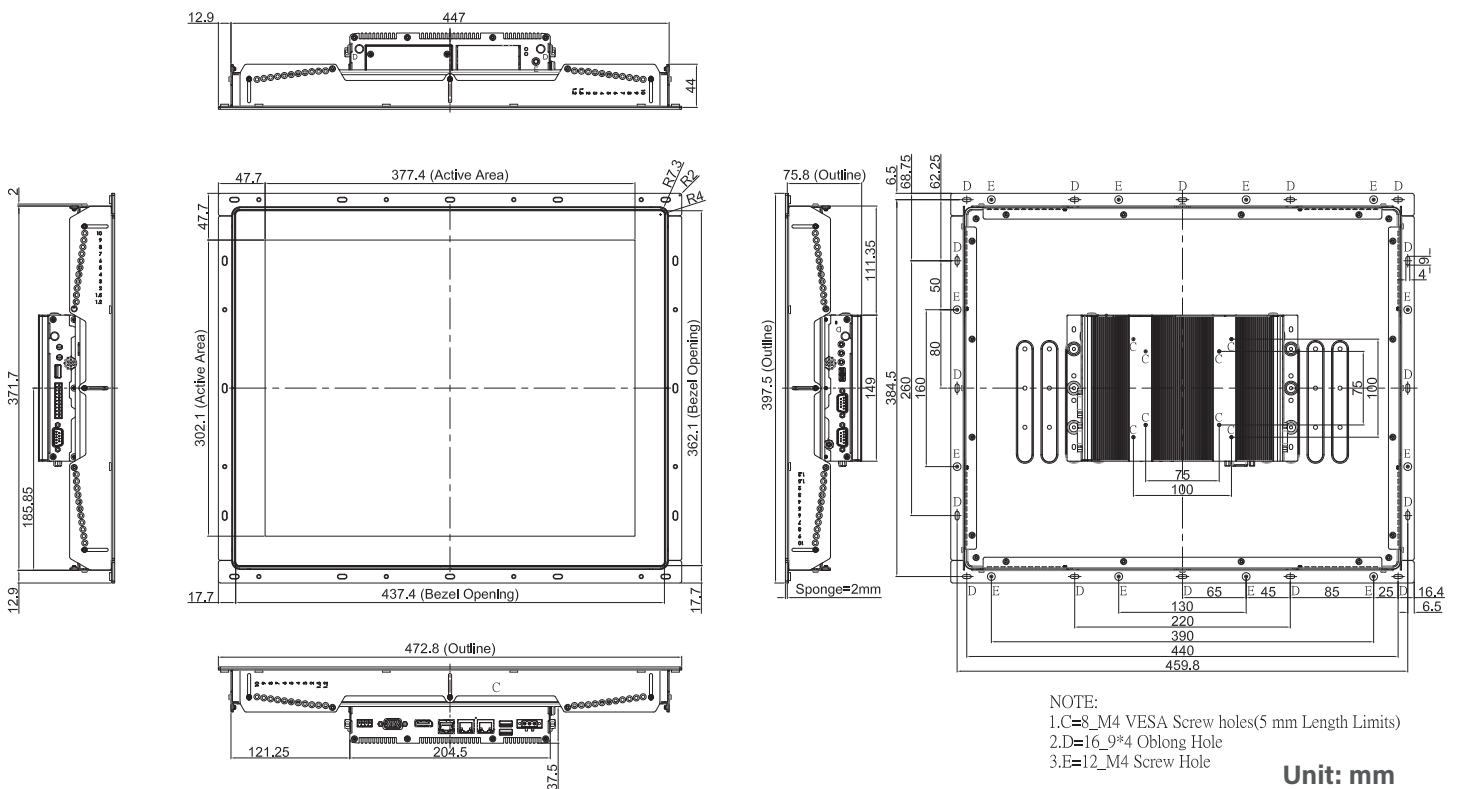

## Ordering Information

### Available Models

| Model No.                    | Description   |
|------------------------------|---|
| CO-119C-R10/P1201-X6425E-R10 | 19" TFT-LCD SXGA 5:4 Open Frame Display Modular Panel PC with Intel Atom x6425E Quad Core Processor |
| CO-119C-R10/P1201-X6211E-R10 | 19" TFT-LCD SXGA 5:4 Open Frame Display Modular Panel PC with Intel Atom x6211E Dual Core Processor |

### Model Configuration

|                      | CO-119C | P1201-X6425E | P1201-X6211E |
|----------------------|---------|--------------|--------------|
| CO-119C/P1201-X6425E | V       | V            | --           |
| CO-119C/P1201-X6211E | V       | --           | V            |

V : Compatible

### Package Checklist

|   |  |
|---|--|
| • CO-119C/P1201 Series Panel PC x 1         | • Power Terminal Block Connector (Female) x 1      |
| • Thermal Pad (for CPU Thermal Block) x 1   | • Screw Pack x 1                                   |
| • DIO Terminal Block Connector (Female) x 1 | • Remote Power On/Off Terminal Block Connector x 1 |

### Optional Modules and Accessories

| Model No.     | Description  |
|---------------|--|
| CFM-PoE02     | CFM Module with PoE Control Function, Individual Port 25.5W                              |
| CFM-IGN101    | CFM Module with Power Ignition Sensing Control Function, 12V/24V Selectable (43 x 36 mm) |
| URM01         | CFM Module with Power Ignition Sensing Control Function, 12V/24V Selectable (43 x 36 mm) |
| GST60A12-CIN1 | Adapter AC/DC 12V 5A 60W, GST60A12-CIN1, wide temp(-30°C ~ +70°C)                        |
| GST120A24-CIN | Adapter AC/DC 24V 5A 120W, GST120A24-CIN, wide temp (-30°C ~ +70°C), level VI            |